





# ShelterLite™ Lighting Kit Assembly Instructions

Description of Parts:		Quantity
	Cable	1
	Light Cage	2
	Cable Ties	30
	S-Hooks	2



UL / CSA  
Approved

**NOTE:** Review all parts included in the kit.

DESCRIPTION	MODEL #
ShelterLite™ Lighting Kit	14501
ShelterLite™ Lighting Kit	14502

## RECOMMENDED TOOLS



Please read instructions **COMPLETELY** before assembly. This shelter **MUST** be securely anchored. **THIS IS A TEMPORARY STRUCTURE AND NOT RECOMMENDED AS A PERMANENT STRUCTURE.**

**Before you start:** 2+ individual recommended for assembly, approximate time 20 min.

  
 150 Callender Road  
 Watertown, CT 06795  
 www.shelterlogic.com

**1-800-524-9970**

Canada:  
**1-800-559-6175**

## 1. ATTACH LIGHT CAGES TO FRAME

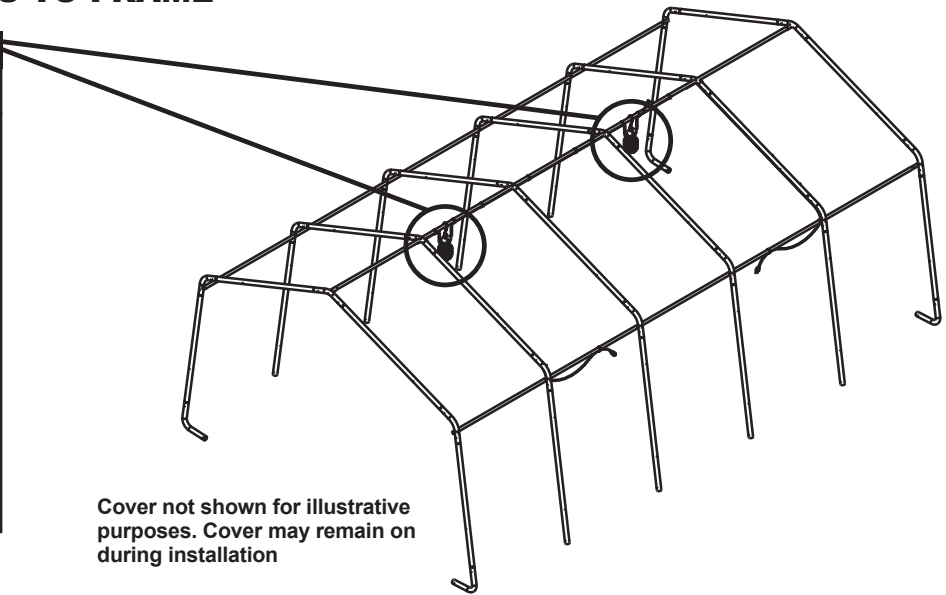
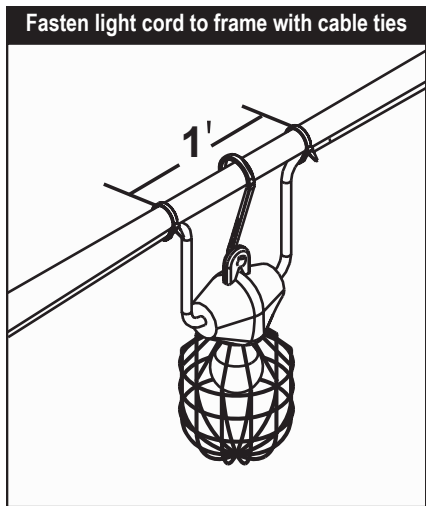

## 2. SECURE LIGHT CORD ENDS TO FRAME.

Create a 4" loop or dip in the light cord that is lower than plug ends to allow any condensation to flow away.

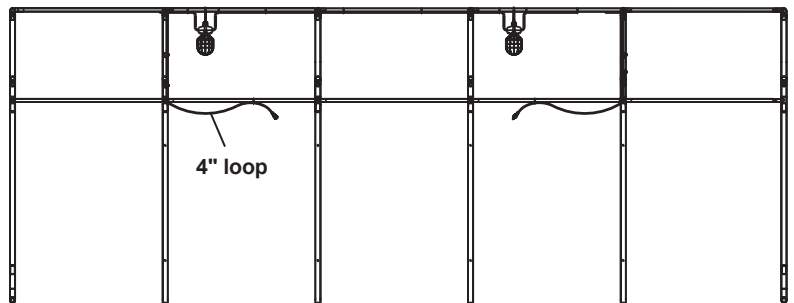

## 3. INSTALL LIGHT BULBS. MAXIMUM 150 WATTS







## 4. RUN ELECTRICAL POWER TO THE SHELTER

*Run electrical power to shelter using only a UL approved outdoor power cord.*

- A. Place the power cord under the cover and plug into male end of the ShelterLite cord.
- B. Secure any loose cord to the frame with cable ties.

# ShelterLite™ Kit De Lumière

## LES TRADUCTIONS FRANÇAISES D'INSTRUCTION D'ASSEMBLAGE

Description des Produits:		Quantité
	Câble électrique	1
	Lanterne	2
	Attache de câble	30
	Attache de câble	2



Homologué  
UL/CSA

Familiarisez vous avec toutes les pièces incluent dans le kit.

DESCRIPTION	MODÈLE N°
ShelterLite™ Kit de lumière	14501
ShelterLite™ Kit de lumière	14502

### OUTILS RECOMMANDÉS



Lire **TOUTES** les instructions avant de monter. Cet abri **DOIT** être bien ancré.  
Ceci est une structure temporaire, il n'est pas recommandé d'en faire une structure permanente.

**Avant de commencer:** Il faut 2 personnes ou plus pour le montage qui prend environ 2 heures.

  
150 Callender Road  
Watertown, CT 06795  
www.shelterlogic.com

**1-800-524-9970**

Canada:  
**1-800-559-6175**

## 1. ATTACHEZ LES LANTERNES A LA CHARPENTE

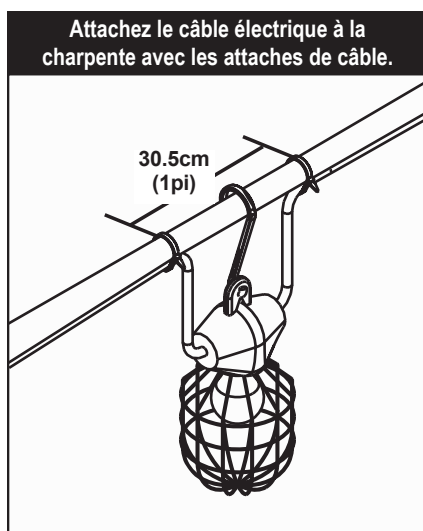

La couverture n'est pas montrée pour des raisons illustratives. La couverture peut restée pendant l'installation.

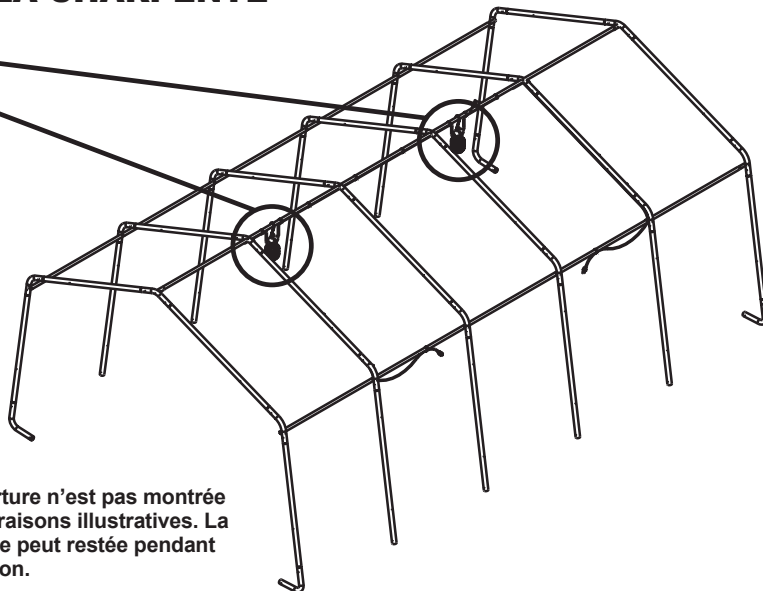

## 2. SECURISEZ LE BOUT DES CABLES A LA CHARPENTE.

Créez une boucle de 10cm (4 po), ou une courbe dans le câble, qui doit être plus bas que la prise pour permettre à toute condensation de coulée.

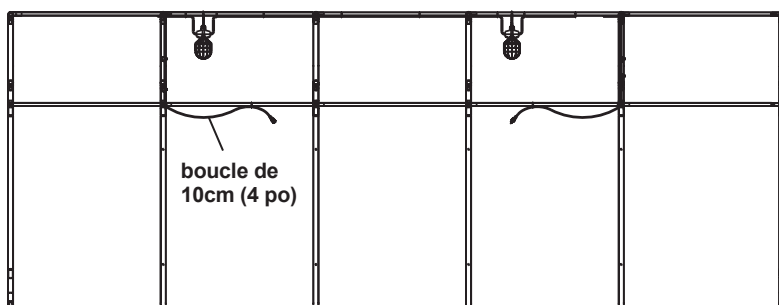

## 3. INSTALEZ LES AMPOULES. 150 WATTS AU MAXIMUM







## 4. FAIRE COURIR UNE RALONGE ELECTRIQUE JUSQUE DANS L'ABRI

*Utilisez uniquement une rallonge électrique approuvée par UL comme rallonge extérieure pour fournir de l'électricité dans l'abri.*

- A. Passez la rallonge sous la couverture et branchez-la sur la prise mâle du câble Shelterlogic
- B. Sécurisez tout câble qui ne sont pas attachez avec les attaches de câble.

# ShelterLite™ Kit De Iluminación

## INSTRUCCIONES DE ENSAMBLAJE EN ESPAÑOL

Descripción de los Productos:		Cantidad
	Cable	1
	Jaula de iluminación	2
	Atadura de cables	30
	Ganchos-S	2



aprobado  
UL/CSA

Revise todas las piezas incluidas en el kit.

DESCRIPCIÓN	MODELO N°
ShelterLite™ Kit De Iluminación	14501
ShelterLite™ Kit De Iluminación	14502

### HERRAMIENTAS RECOMENDADAS



Por favor lea las instrucciones **COMPLETAMENTE** antes de ensamblar. Este cobertizo **DEBERÁ** anclarse de forma segura. Verifique tubos más grande interiores de diámetro para tubos más pequeños. No **VUELVA** el PRODUCTO A LA TIENDA. Las Partes perdidas, Ayuda de Reemplazo o Asamblea, **LLAMA** el Servicio de atención al cliente:

Antes de comenzar: Se necesitan 2 o más personas para el ensamblaje. Tiempo aproximado: 20 min.

  
**ShelterLogic**<sup>®</sup>  
 150 Callender Road  
 Watertown, CT 06795  
[www.shelterlogic.com](http://www.shelterlogic.com)

**1-800-524-9970**

Canada:  
**1-800-559-6175**

## 1. ATE LAS JAULAS DE ILUMINACIÓN AL MARCO

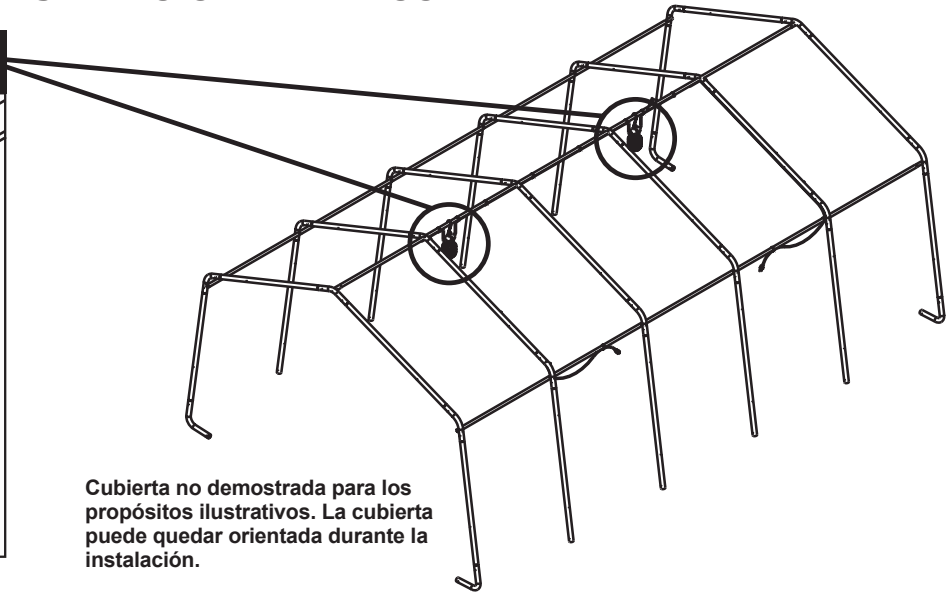
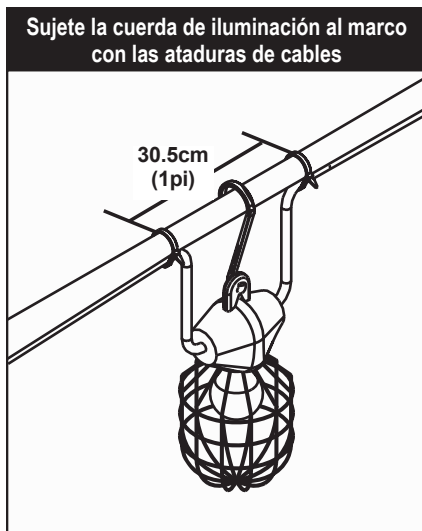

## 2. ASEGURE LOS EXTREMOS DE LA CUERDA DE ILUMINACIÓN AL MARCO.

Cree una curva o lazada de 10cm (4po) pulgadas en la cuerda de iluminación que sea más baja que los extremos del enchufe para permitir que fluya y se aleje cualquier condensación.

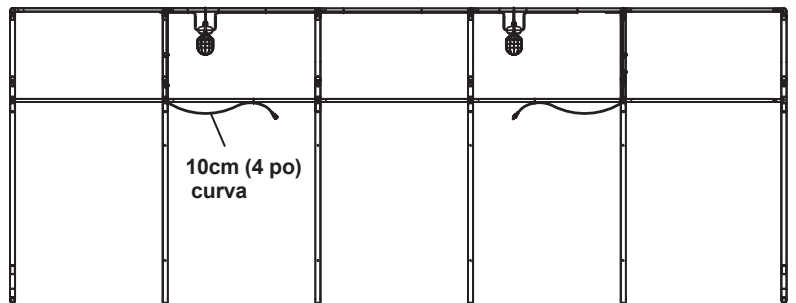

## 3. INSTALE LAS BOMBILLAS. MÁXIMO 150 VATIOS



## 4. TENDER CORRIENTE ELECTIRCA AL COBERTIZO

*Tender corriente eléctrica al cobertizo usando solamente un cable eléctrico al aire libre aprobado por UL.*

- A. Coloque el cable eléctrico debajo de la cubierta y enchufe en el extremo masculino de el cable de ShelterLite.
- B. Asegure cualquier cable flojo al marco con las ataduras de cables.