

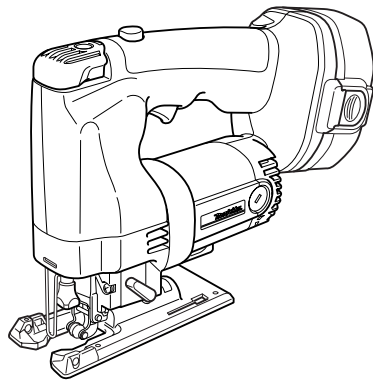

# Cordless Jig Saw

MODEL 4334D



## I N S T R U C T I O N M A N U A L

**⚠ WARNING:**

For your personal safety, READ and UNDERSTAND before using.  
SAVE THESE INSTRUCTIONS FOR FUTURE REFERENCE.

[www.makitatools.com](http://www.makitatools.com)

# SPECIFICATIONS

Model		4334D	
Length of stroke		26 mm (1")	
Max. cutting capacities	Wood	135 mm (5-5/16")	
	Mild steel	10 mm (3/8")	
	Aluminum	20 mm (13/16")	
Strokes per minute		500 - 2,800/min	
Overall length		281 mm (11")	
Net weight		3.4 kg (7.5 lbs)	
Battery Charger	DC1804		
Input	A. C. only 50 Hz - 60 Hz		
Output	D. C. 7.2 V - 18 V		
Battery Cartridge	1822	1834	1835
Voltage	18 V		
Charging time	45 min.	60 min.	70 min.

- Manufacturer reserves the right to change specifications without notice.
- Specifications may differ from country to country.

# GENERAL SAFETY RULES

USA003-1

(FOR ALL BATTERY OPERATED TOOLS)

## **⚠ WARNING:**

**Read and understand all instructions.** Failure to follow all instructions listed below, may result in electric shock, fire and/or serious personal injury.

# SAVE THESE INSTRUCTIONS

---

## Work Area

1. **Keep your work area clean and well lit.** Cluttered benches and dark areas invite accidents.
2. **Do not operate power tools in explosive atmospheres, such as in the presence of flammable liquids, gases, or dust.** Power tools create sparks which may ignite the dust or fumes.
3. **Keep bystanders, children, and visitors away while operating a power tool.** Distractions can cause you to lose control.

## Electrical Safety

4. **A battery operated tool with integral batteries or a separate battery pack must be recharged only with the specified charger for the battery.** A charger that may be suitable for one type of battery may create a risk of fire when used with another battery.
5. **Use battery operated tool only with specifically designated battery pack.** Use of any other batteries may create a risk of fire.

## Personal Safety

6. **Stay alert, watch what you are doing, and use common sense when operating a power tool. Do not use tool while tired or under the influence of drugs, alcohol, or medication.** A moment of inattention while operating power tools may result in serious personal injury.
7. **Dress properly. Do not wear loose clothing or jewelry. Contain long hair. Keep your hair, clothing, and gloves away from moving parts.** Loose clothes, jewelry, or long hair can be caught in moving parts.
8. **Avoid accidental starting. Be sure switch is in the locked or off position before inserting battery pack.** Carrying tools with your finger on the switch or inserting the battery pack into a tool with the switch on invites accidents.

9. **Remove adjusting keys or wrenches before turning the tool on.** A wrench or a key that is left attached to a rotating part of the tool may result in personal injury.
10. **Do not overreach. Keep proper footing and balance at all times.** Proper footing and balance enable better control of the tool in unexpected situations.
11. **Use safety equipment. Always wear eye protection.** Dust mask, non-skid safety shoes, hard hat, or hearing protection must be used for appropriate conditions.

## Tool Use and Care

12. **Use clamps or other practical way to secure and support the workpiece to a stable platform.** Holding the work by hand or against your body is unstable and may lead to loss of control.
13. **Do not force tool. Use the correct tool for your application.** The correct tool will do the job better and safer at the rate for which it is designed.
14. **Do not use tool if switch does not turn it on or off.** A tool that cannot be controlled with the switch is dangerous and must be repaired.
15. **Disconnect battery pack from tool or place the switch in the locked or off position before making any adjustments, changing accessories, or storing the tool.** Such preventive safety measures reduce the risk of starting the tool accidentally.
16. **Store idle tools out of reach of children and other untrained persons.** Tools are dangerous in the hands of untrained users.
17. **When battery pack is not in use, keep it away from other metal objects like: paper clips, coins, keys, nails, screws, or other small metal objects that can make a connection from one terminal to another.** Shorting the battery terminals together may cause sparks, burns, or a fire.

- 
18. **Maintain tools with care. Keep cutting tools sharp and clean.** Properly maintained tools with sharp cutting edge are less likely to bind and are easier to control.
  19. **Check for misalignment or binding of moving parts, breakage of parts, and any other condition that may affect the tool's operation. If damaged, have the tool serviced before using.** Many accidents are caused by poorly maintained tools.
  20. **Use only accessories that are recommended by the manufacturer for your model.** Accessories that may be suitable for

one tool may create a risk of injury when used on another tool.

## SERVICE

21. **Tool service must be performed only by qualified repair personnel.** Service or maintenance performed by unqualified personnel may result in a risk of injury.
22. **When servicing a tool, use only identical replacement parts. Follow instructions in the Maintenance section of this manual.** Use of unauthorized parts or failure to follow Maintenance instructions may create a risk of shock or injury.

---

# ADDITIONAL SAFETY RULES

USB030-2

**DO NOT let comfort or familiarity with product (gained from repeated use) replace strict adherence to cordless jig saw safety rules. If you use this tool unsafely or incorrectly, you can suffer serious personal injury.**

1. Hold tool by insulated gripping surfaces when performing an operation where the cutting tool may contact hidden wiring. Contact with a "live" wire will make exposed metal parts of the tool "live" and shock the operator.
2. Be aware that this tool is always in an operating condition, because it does not have to be plugged into an electrical outlet.
3. Always use safety glasses or goggles. Ordinary eye or sun glasses are NOT safety glasses.
4. Avoid cutting nails. Inspect for and remove all nails from the workpiece before operation.
5. Do not cut hollow pipe.
6. Do not cut oversize workpiece.
7. Check for the proper clearance beneath the workpiece before cutting so that the blade will not strike the floor, workbench, etc.
8. Hold the tool firmly.
9. Check the blade is not contacting the workpiece before the switch is turned on.
10. Keep hands away from moving parts.
11. Do not leave the tool running. Operate the tool only when hand-held.
12. Always switch off and wait for the blade to come to a complete stop before removing the blade from the workpiece.
13. Do not touch the blade or the workpiece immediately after operation; they may be extremely hot and could burn your skin.

---

14. Some material contains chemicals which may be toxic. Take caution to prevent

dust inhalation and skin contact. Follow material supplier safety data.

---

## SAVE THESE INSTRUCTIONS

**⚠ WARNING:**  
**MISUSE or failure to follow the safety rules stated in this instruction manual may cause serious personal injury.**

---

## SYMBOLS

USD301-1

The followings show the symbols used for tool.

V ..... volts

n<sub>0</sub> .....no load speed

⎓ ..... direct current

.../min.....revolutions or reciprocation per minute

---

## IMPORTANT SAFETY INSTRUCTIONS FOR CHARGER & BATTERY CARTRIDGE

USC001-3

- 1. SAVE THESE INSTRUCTIONS** - This manual contains important safety and operating instructions for battery charger.
- 2. Before using battery charger**, read all instructions and cautionary markings on (1) battery charger, (2) battery, and (3) product using battery.
- 3. CAUTION** - To reduce risk of injury, charge only **MAKITA** rechargeable batteries marked on the charger label. Other types of batteries may burst causing personal injury and damage.
- 4. Do not expose charger to rain or snow.**
- 5. Use of an attachment not recommended or sold by the battery charger manufacturer may result in a risk of fire, electric shock, or injury to persons.**
- 6. To reduce risk of damage to electric plug and cord**, pull by plug rather than cord when disconnecting charger.

7. Make sure cord is located so that it will not be stepped on, tripped over, or otherwise subjected to damage or stress.
8. An extension cord should not be used unless absolutely necessary. Use of improper extension cord could result in a risk of fire and electric shock. If extension cord must be used, make sure:
  - a. That pins on plug of extension cord are the same number, size, and shape as those of plug on charger;
  - b. That extension cord is properly wired and in good electrical condition;
  - c. That wire size is at least as large as the one specified in the table below.

**Table 1: RECOMMENDED MINIMUM AWG SIZE FOR EXTENSION CORDS FOR BATTERY CHARGERS**

Length of Cord (Feet)	25	50	100	150
AWG Size of Cord	18	18	18	16

9. Do not operate charger with damaged cord or plug - replace them immediately.
10. Do not operate charger if it has received a sharp blow, been dropped, or otherwise damaged in any way; take it to a qualified serviceman.
11. Do not disassemble charger or battery cartridge; take it to a qualified serviceman when service or repair is required, Incorrect reassembly may result in a risk of electric shock or fire.
12. To reduce risk of electric shock, unplug charger from outlet before attempting any maintenance or cleaning. Turning off controls will not reduce this risk.
13. The battery charger is not intended for use by young children or infirm persons without supervision.
14. Young children should be supervised to ensure that they do not play with the battery charger.
15. If operating time has become excessively shorter, stop operating immediately. It may result in a risk of overheating, possible burns and even an explosion.
16. If electrolyte gets into your eyes, rinse them out with clear water and seek medical attention right away. It may result in loss of your eyesight.

---

## **ADDITIONAL SAFETY RULES FOR CHARGER & BATTERY CARTRIDGE**

1. Do not charge Battery Cartridge when temperature is BELOW 10°C (50°F) or ABOVE 40°C (104°F).
2. Do not attempt to use a step-up transformer, an engine generator or DC power receptacle.
3. Do not allow anything to cover or clog the charger vents.
4. Always cover the battery terminals with the battery cover when the battery cartridge is not used.
5. Do not short the battery cartridge:

- 
- (1) Do not touch the terminals with any conductive material.
  - (2) Avoid storing battery cartridge in a container with other metal objects such as nails, coins, etc.
  - (3) Do not expose battery cartridge to water or rain.

A battery short can cause a large current flow, overheating, possible burns and even a breakdown.

6. Do not store the tool and Battery Cartridge in locations where the temperature may reach or exceed 50°C (122°F).
7. Do not incinerate the Battery Cartridge even if it is severely damaged or is completely worn out. The battery cartridge can explode in a fire.
8. Be careful not to drop, shake or strike battery.
9. Do not charge inside a box or container of any kind. The battery must be placed in a well ventilated area during charging.

---

## SAVE THESE INSTRUCTIONS

## FUNCTIONAL DESCRIPTION

### ⚠ CAUTION:

- Always be sure that the tool is switched off and the battery cartridge is removed before adjusting or checking function on the tool.

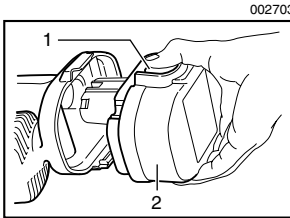

1. Button
2. Battery cartridge

### Installing or removing battery cartridge

- Always switch off the tool before insertion or removal of the battery cartridge.
- To remove the battery cartridge, withdraw it from the tool while pressing the buttons on both sides of the cartridge.
- To insert the battery cartridge, align the tongue on the battery cartridge with the groove in the housing and slip it into place. Always insert it all the way until it locks in place with a little click. If not, it may accidentally fall out of the tool, causing injury to you or someone around you.
- Do not use force when inserting the battery cartridge. If the cartridge does not slide in easily, it is not being inserted correctly.

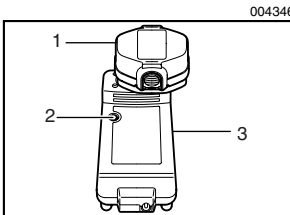

1. Battery cartridge
2. Charging light
3. Battery charger

### Charging

1. Plug the battery charger into the proper AC voltage source. The charging light will flash in green color.
2. Insert the battery cartridge so that the plus and minus terminals on the battery cartridge are on the same sides as their respective markings on the charger. Insert the cartridge fully into the port so that it rests on the charger port floor.
3. When the battery cartridge is inserted, the charging light color will change from green to red and charging will begin. The charging light will remain lit steadily during charging.
4. When the charging light color changes from red to green, the charging cycle is complete.
5. If you leave the battery cartridge in the charger after the charging cycle is complete, the charger will switch into its "trickle charge (maintenance charge)" mode.
6. After charging, unplug the charger from the power source.

---

**NOTE:**

- The battery charger is for charging Makita battery cartridge. Never use it for other purposes or for other manufacturer's batteries.
- When you charge a new battery cartridge or a battery cartridge which has not been used for a long period of time, it may not accept a full charge. This is a normal condition and does not indicate a problem. You can recharge the battery cartridge fully after discharging it completely and recharging a couple of times.
- If you charge a battery cartridge from a just operated tool or a battery cartridge which has been left in a location exposed to direct sunlight or heat for a long time, the charging light may flash in red color. If this occurs, wait for a while. Charging will begin after the battery cartridge cools. The battery cartridge will cool faster if you remove the battery cartridge from the battery charger.
- If the charging light flashes alternately in green and red color, charging is not possible. The terminals on the charger or battery cartridge are clogged with dust or the battery cartridge is worn out or damaged.

**Trickle charge (Maintenance charge)**

If you leave the battery cartridge in the charger to prevent spontaneous discharging after full charge, the charger will switch into its "trickle charge (maintenance charge)" mode and keep the battery cartridge fresh and fully charged.

**Tips for maintaining maximum battery life**

1. Charge the battery cartridge before completely discharged.  
Always stop tool operation and charge the battery cartridge when you notice less tool power.
2. Never recharge a fully charged battery cartridge.  
Overcharging shortens the battery service life.
3. Charge the battery cartridge with room temperature at 10°C - 40°C (50°F - 104°F).  
Let a hot battery cartridge cool down before charging it.
4. Charge the Nickel Metal Hydride battery cartridge when you do not use it for more than six months.

002706

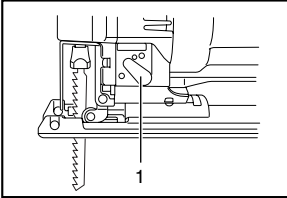

1. Cutting action changing lever

## Selecting the cutting action

This tool can be operated with an orbital or a straight line (up and down) cutting action. The orbital cutting action thrusts the blade forward on the cutting stroke and greatly increases cutting speed.

To change the cutting action, just turn the cutting action changing lever to the desired cutting action position. Refer to the table to select the appropriate cutting action.

002788

Position	Cutting action	Applications
0	Straight line cutting action	For cutting mild steel, stainless steel and plastics. For clean cuts in wood and plywood.
I	Small orbit cutting action	For cutting mild steel, aluminum and hard wood.
II	Medium orbit cutting action	For cutting wood and plywood. For fast cutting in aluminum and mild steel.
III	Large orbit cutting action	For fast cutting in wood and plywood.

002709

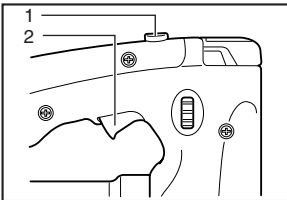

1. Lock-off button

2. Switch trigger

## Switch action

### ⚠ CAUTION:

- Before inserting the battery cartridge into the tool, always check to see that the switch trigger actuates properly and returns to the "OFF" position when released.

To prevent the switch trigger from being accidentally pulled, a lock-off button is provided.

To start the tool, depress the lock-off button and pull the switch trigger. Release the switch trigger to stop.

002712

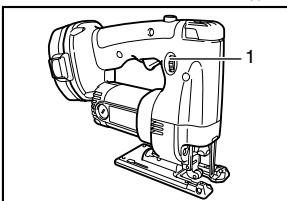

1. Speed adjusting dial

## Speed adjusting dial

The tool speed can be infinitely adjusted between 500 and 2,800 strokes per minute by turning the adjusting dial. Higher speed is obtained when the dial is turned in the direction of number 5; lower speed is obtained when it is turned in the direction of number 1.

Refer to the table to select the proper speed for the workpiece to be cut. However, the appropriate speed may differ with the type or thickness of the workpiece. In general, higher speeds will allow you to cut workpieces faster but the service life of the blade will be reduced.

Workpiece to be cut	Number on adjusting dial
Wood	3 - 5
Mild steel	3 - 5
Stainless steel	3 - 4
Aluminum	2 - 3
Plastics	1 - 4

**⚠ CAUTION:**

- If the tool is operated continuously at low speeds for a long time, the motor will get overloaded and heated up.
- The speed adjusting dial can be turned only as far as 5 and back to 1. Do not force it past 5 or 1, or the speed adjusting function may no longer work.

## ASSEMBLY

**⚠ CAUTION:**

- Always be sure that the tool is switched off and the battery cartridge is removed before carrying out any work on the tool.

### Installing or removing saw blade

**⚠ CAUTION:**

- Always clean out all chips or foreign matter adhering to the blade and/or blade holder. Failure to do so may cause insufficient tightening of the blade, resulting in a serious personal injury.
- Do not touch the blade or the workpiece immediately after operation; they may be extremely hot and could burn your skin.
- Always secure the blade firmly. Insufficient tightening of the blade may cause blade breakage or serious personal injury.

### Installation

1. Push the blade installing lever in the (1) direction to release it.

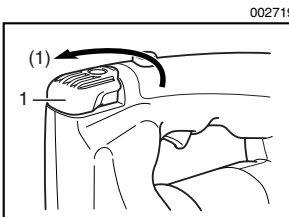

1. Blade installing lever

002720

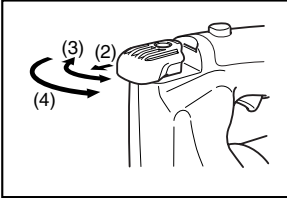

2. Pull the blade installing lever in the (2) direction until it stops with a little click. If you have difficulty pulling it out, try to do so while moving it back and forth in the (3) direction.
3. Rotate the blade installing lever in the (4) direction until the clamp protrudes 5 - 7 mm from the blade holder.

**⚠ CAUTION:**

- If you rotate the blade installing lever excessively, the clamp will also rotate and finally come off. In this case, re-install it properly as lately described in "Installing clamp".

002721

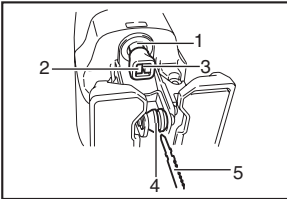

1. Blade holder
2. Clamp
3. Slot
4. Roller
5. Blade

4. With the blade teeth facing forward, insert the blade into the blade holder as far as it will go. Make sure that the back edge of the blade fits properly into the groove of the roller.

002722

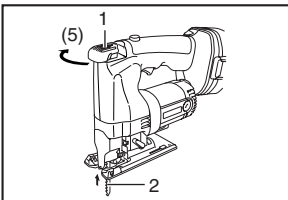

1. Blade installing lever
2. Blade

5. With the blade held against the blade holder, rotate the blade installing lever in the (5) direction until it stops.

002723

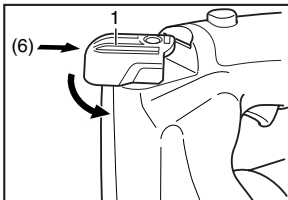

1. Blade installing lever

6. With the blade installing lever held in this position, push it in the (6) direction. Then rotate the blade installing lever to its original position.

002719



1. Blade installing lever

002720

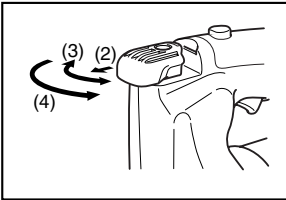

2. Pull the blade installing lever in the (2) direction until it stops with a little click. If you have difficulty pulling it out, try to do so while moving it back and forth in the (3) direction.
3. Rotate the blade installing lever in the (4) direction and remove the blade.

002724

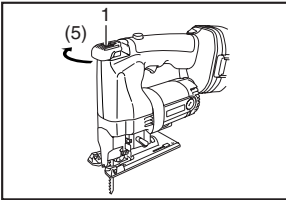

1. Blade installing lever

002732

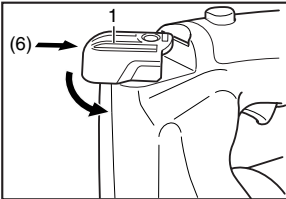

1. Blade installing lever

4. Rotate the blade installing lever in the (5) direction until it stops.

5. With the blade installing lever held in this position, push it in the (6) direction. Then rotate the blade installing lever to its original position.

002734

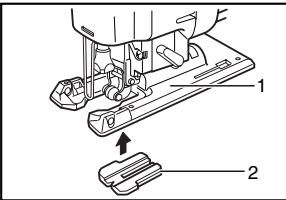

1. Base  
2. Anti-splintering device

### Anti-splintering device

For splinter-free cuts, the anti-splintering device can be used. To install the anti-splintering device, move the base all the way forward and fit it into the base from the back of base.

#### NOTE:

- The anti-splintering device cannot be used when making bevel cuts.

002736

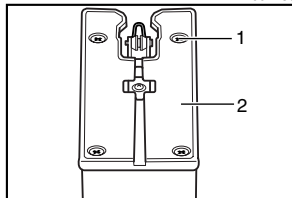

1. Screw
2. Plastic base plate

### Plastic base plate (optional accessory)

Use the plastic base plate when cutting decorative veneers, plastics, etc. It protects sensitive surfaces from damage. To replace the base plate, remove the four screws.

002738

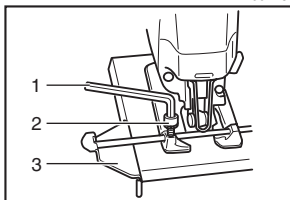

1. Hex wrench
2. Bolt
3. Rip fence (Guide rule)

### Rip fence (optional accessory)

When cutting widths of under 150 mm (5 - 29/32") repeatedly, use of the rip fence (guide rule) will assure fast, clean, straight cuts. To install it, loosen the bolt on the front of the base. Slip in the rip fence and secure the bolt.

002739

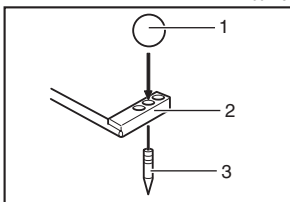

1. Threaded knob
2. Circular guide
3. Pin

### Circular guide (optional accessory)

Use of the circular guide insures clean, smooth cutting of circles under 200 mm (7 - 7/8") in radius. Insert the pin through the center hole and secure it with the threaded knob. Move the base of the tool forward fully. Then install the circular guide on the base in the same manner as the rip fence (guide rule).

002740

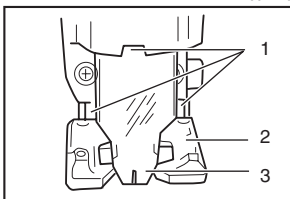

1. Notches
2. Base
3. Plastic cover

### Vacuum head (optional accessory)

The vacuum head is recommended to perform clean cutting operations. Install the plastic cover on the tool by fitting it into the notches in the tool.

002741

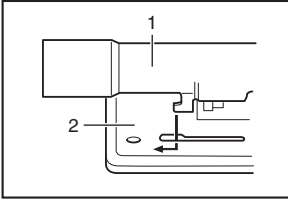

1. Vacuum head
2. Base

To attach the vacuum head on the tool, insert the hooks of the vacuum head into the hole in the base. The vacuum head can be installed on either left or right side of the base.

Then connect a Makita vacuum cleaner to the vacuum head.

002742

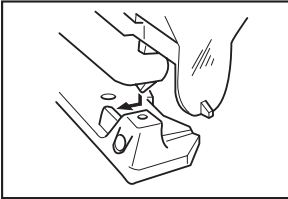

## OPERATION

### ⚠ CAUTION:

- Always hold the base flush with the workpiece. Failure to do so may cause blade breakage, resulting in a serious injury.
- Advance the tool very slowly when cutting curves or scrolling. Forcing the tool may cause a slanted cutting surface and blade breakage.

002745

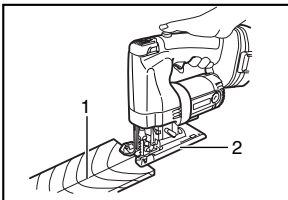

1. Cutting line
2. Base

Turn the tool on without the blade making any contact and wait until the blade attains full speed. Then rest the base flat on the workpiece and gently move the tool forward along the previously marked cutting line.

### NOTE:

- If the tool is operated continuously until the battery cartridge has discharged, allow the tool to rest for 15 minutes before proceeding with a fresh battery.

002754

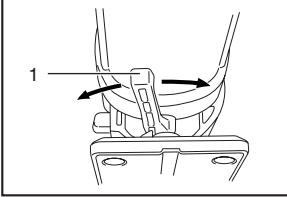

1. Base securing lever

## Bevel cutting

### ⚠ CAUTION:

- Always be sure that the tool is switched off and the battery cartridge is removed before tilting the base.

With the base tilted, you can make bevel cuts at any angle between 0° and 45° (left or right).

Loosen the base securing lever and move the base so that the dent mark in the motor housing is aligned with the slot in the base.

Tilt the base until the desired bevel angle is obtained. The edge of the motor housing indicates the bevel angle by graduations. Then tighten the base securing lever to secure the base.

### NOTE:

- Always remove the plastic cover (chip shield) from the tool when you make bevel cuts using an optional rip fence (guide rule) or circular guide.

002755

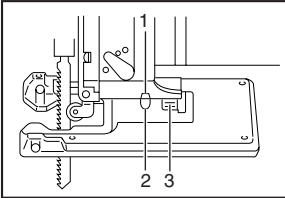

1. Dent mark
2. Slot
3. Graduation

002759

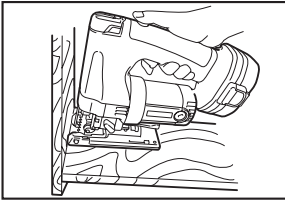

## Front flush cuts

Loosen the base securing lever and slide the base all the way back. Then tighten the base securing lever to secure the base.

## Cutouts

Cutouts can be made with either of two methods A or B.

### A) Boring a starting hole

For internal cutouts without a lead-in cut from an edge, pre-drill a starting hole 12 mm (1/2") or more in diameter. Insert the blade into this hole to start your cut.

002765

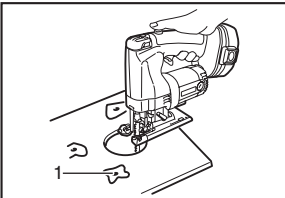

1. Starting hole

002766

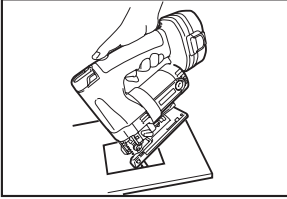

## B) Plunge cutting

You need not bore a starting hole or make a lead-in cut if you carefully do as follows.

- (1) Tilt the tool up on the front edge of the base with the blade point positioned just above the workpiece surface.
- (2) Apply pressure to the tool so that the front edge of the base will not move when you switch on the tool and gently lower the back end of the tool slowly.
- (3) As the blade pierces the workpiece, slowly lower the base of the tool down onto the workpiece surface.
- (4) Complete the cut in the normal manner.

002770

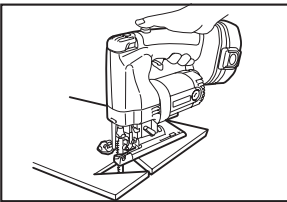

## Finishing edges

To trim edges or make dimensional adjustments, run the blade lightly along the cut edges.

## Metal cutting

Always use a suitable coolant (cutting oil) when cutting metal. Failure to do so will cause significant blade wear. The underside of the workpiece can be greased instead of using a coolant.

# MAINTENANCE

### ⚠ CAUTION:

- Always be sure that the tool is switched off and the battery cartridge is removed before attempting to perform inspection or maintenance.

### Cleaning clamp on blade holder

If chips or foreign matter get into the clamp on the blade holder, clean out the clamp after removing it from the blade holder.

002719



1. Blade installing lever

002720

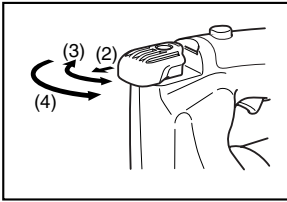

002993

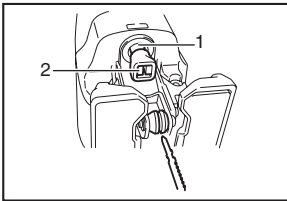

1. Blade holder  
2. Clamp

002781

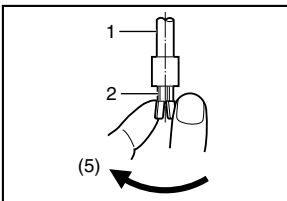

1. Blade holder  
2. Clamp

## Removing clamp

1. Push the blade installing lever in the (1) direction to release it.
2. Pull the blade installing lever in the (2) direction until it stops with a little click. If you have difficulty pulling it out, try to do so while moving it back and forth in the (3) direction.
3. Rotate the blade installing lever in the (4) direction until it stops. The clamp will protrude from the blade holder.
4. Remove the clamp from the blade holder while rotating the clamp in the (5) direction.

## Installing clamp

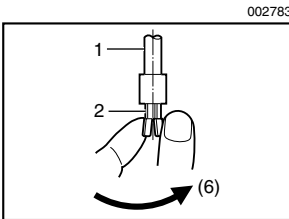
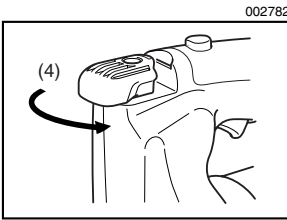

1. Blade holder
2. Clamp

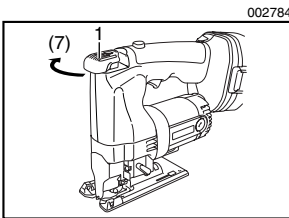

1. Blade installing lever

1. Make sure that the blade installing lever has been rotated in the (4) direction until it stops.

2. Insert the clamp into the blade holder while rotating it in the (6) direction one quarter to one full turn so that its slot will face forward.

### ⚠ CAUTION:

- Do not rotate the clamp more than one full turn when inserting in into the blade holder. If you do so, the blade may not be tightened firmly.

3. Grasp the clamp with your fingers so that it will not turn, then rotate the blade installing lever in the (7) direction until it stops. The clamp will go in the blade holder.

## Replacing carbon brushes

Remove and check the carbon brushes regularly. Replace when they wear down to the limit mark. Keep the carbon brushes clean and free to slip in the holders. Both carbon brushes should be replaced at the same time. Use only identical carbon brushes.

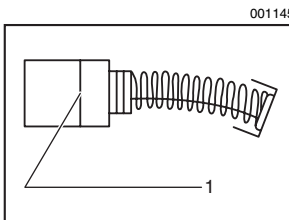

1. Limit mark

002786

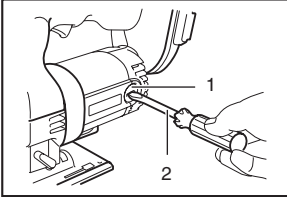

1. Brush holder cap
2. Screwdriver

Use a screwdriver to remove the brush holder caps. Take out the worn carbon brushes, insert the new ones and secure the brush holder caps.

To maintain product SAFETY and RELIABILITY, repairs, any other maintenance or adjustment should be performed by Makita Authorized or Factory Service Centers, always using Makita replacement parts.

EN0001-1

### Recycling the Battery

The only way to dispose of a Makita battery is to recycle it. The law prohibits any other method of disposal.

To recycle the battery:

1. Remove the battery from the tool.
2. a) Take the battery to your nearest Makita Factory Service Center  
or  
b) Take the battery to your nearest Makita Authorized Service Center or Distributor that has been designated as a Makita battery recycling location.

*Call your nearest Makita Service Center or Distributor to determine the location that provides Makita battery recycling. See your local Yellow Pages under "Tools-Electric".*

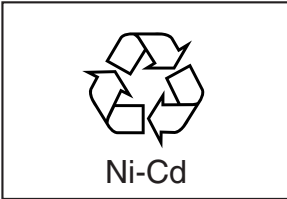

---

## ACCESSORIES

**⚠ CAUTION:**

- These accessories or attachments are recommended for use with your Makita tool specified in this manual. The use of any other accessories or attachments might present a risk of injury to persons. Only use accessory or attachment for its stated purpose.

If you need any assistance for more details regarding these accessories, ask your local Makita service center.

- Jig saw blades
- Various type of Makita genuine batteries and chargers
- Hex wrench 3
- Rip fence (guide rule) set
- Circular guide set
- Plastic base plate
- Anti-splintering device
- Plastic cover
- Vacuum head
- Hose (For vacuum cleaner)

---

# Memo

---

---

---

---

---

---

---

---

---

---

---

---

---

---

---

---

---





Cut



First-Class  
Postage  
Required

Post Office will  
not deliver  
without proper  
postage.

**Makita U.S.A., Inc.**  
14930 Northam Street  
La Mirada, CA 90638-5753



Fold



# FACTORY SERVICE CENTERS

1-800-4-MAKITA

RETAIN THIS PORTION FOR YOUR RECORDS

## ARIZONA

3707 E. Broadway Rd., Ste. 6  
Phoenix, AZ 85040  
(602) 437-2850

## CALIFORNIA

41850 Christy St.  
Fremont, CA 94538-5107  
(510) 657-9881

14930 Northam St.  
La Mirada, CA 90638-5753  
(714) 522-8088

1970 Fulton Avenue  
Sacramento, CA 95825  
(916) 482-5197

7674 Clairemont Mesa Blvd.  
San Diego, CA 92111  
(858) 278-4471

16735 Saticoy St., Ste. 105  
Van Nuys, CA 91406  
(818) 782-2440

## COLORADO

11839 E. 51st Ave.  
Denver, CO 80239-2709  
(303) 371-2850

## FLORIDA

750 East Sample Road  
Pompano Beach, FL 33064  
(954) 781-6333

## GEORGIA

4680 River Green Parkway NW  
Duluth, GA 30096  
(770) 476-8911

## ILLINOIS

1450 Feehanville Dr.  
Mt. Prospect, IL 60056-6011  
(847) 297-3100

## MARYLAND

7397 Washington Boulevard,  
Suite 104 Elkridge, MD 21075  
(410) 476-4401

## MASSACHUSETTS

232 Providence Hwy.  
Westwood, MA 02090  
(781) 461-9754

## MINNESOTA

6427 Penn Ave. South  
Richfield, MN 55423  
(612) 869-5199

## MISSOURI

9876 Watson Road  
St. Louis, MO 63126-2221  
(314) 909-9889

## NEBRASKA

4129 S. 84th St.  
Omaha, NE 68127  
(402) 597-2925

## NEVADA

3375 S. Decatur Blvd.  
Suites. 22 - 24  
Las Vegas, NV 89102  
(702) 368-4277

## NEW JERSEY

251 Herrod Blvd.  
Dayton, NJ 08810-1539  
(609) 655-1212

## NEW YORK

4917 Genessee Street  
Cheektowaga, NY 14225  
(716) 685-9503

## OREGON

828 19th Avenue, N.W.  
Portland, OR 97209  
(503) 222-1823

## PENNSYLVANIA

1704 Babcock Blvd.  
Pittsburgh, PA 15209  
(412) 822-7370

## PUERTO RICO

200 Guayama St.  
Hato Rey, PR 00917  
(787) 250-8776

## TENNESSEE

1120 Elm Hill P.  
Suite 170 Nashville, TN 372  
(615) 248-3321

## TEXAS

12801 Stemmons Fwy Ste. 809  
Farmers Branch, TX 75234  
(972) 243-1150

12701 Directors Dr.  
Stafford, TX 77477-3701  
(281) 565-8665

3453 IH-35 North, Ste. 101  
San Antonio, TX 78219  
(210) 228-0676

## WISCONSIN

Lincoln Plaza Shopping Ctr.  
2245 S. 108th St. West Allis, WI  
53227  
(414) 541-4776

## CUSTOMER'S RECORD

<p><b>When you need service:</b> Send complete tool (prepaid) to one of the Makita Factory Service Centers listed, or to an Authorized Makita Service Center. Be sure to attach a letter to the outside of the carton detailing the problem with your tool.</p>	Date Purchased
	Dealer's Name & Address
	Model No.
	Serial No.

# WARNING

Some dust created by power sanding, sawing, grinding, drilling, and other construction activities contains chemicals known to the State of California to cause cancer, birth defects or other reproductive harm. Some examples of these chemicals are:

- lead from lead-based paints,
- crystalline silica from bricks and cement and other masonry products, and
- arsenic and chromium from chemically-treated lumber.

Your risk from these exposures varies, depending on how often you do this type of work. To reduce your exposure to these chemicals: work in a well ventilated area, and work with approved safety equipment, such as those dust masks that are specially designed to filter out microscopic particles.

## MAKITA LIMITED ONE YEAR WARRANTY

### Warranty Policy

Every Makita tool is thoroughly inspected and tested before leaving the factory. It is warranted to be free of defects from workmanship and materials for the period of ONE YEAR from the date of original purchase. Should any trouble develop during this one year period, return the COMPLETE tool, freight prepaid, to one of Makita's Factory or Authorized Service Centers. If inspection shows the trouble is caused by defective workmanship or material, Makita will repair (or at our option, replace) without charge.

This Warranty does not apply where:

- repairs have been made or attempted by others:
- repairs are required because of normal wear and tear:
- the tool has been abused, misused or improperly maintained:
- alterations have been made to the tool.

IN NO EVENT SHALL MAKITA BE LIABLE FOR ANY INDIRECT, INCIDENTAL OR CONSEQUENTIAL DAMAGES FROM THE SALE OR USE OF THE PRODUCT. THIS DISCLAIMER APPLIES BOTH DURING AND AFTER THE TERM OF THIS WARRANTY.

MAKITA DISCLAIMS LIABILITY FOR ANY IMPLIED WARRANTIES, INCLUDING IMPLIED WARRANTIES OF "MERCHANTABILITY" AND "FITNESS FOR A SPECIFIC PURPOSE," AFTER THE ONE YEAR TERM OF THIS WARRANTY.

This Warranty gives you specific legal rights, and you may also have other rights which vary from state to state. Some states do not allow the exclusion or limitation of incidental or consequential damages, so the above limitation or exclusion may not apply to you. Some states do not allow limitation on how long an implied warranty lasts, so the above limitation may not apply to you.

**Makita Corporation of America**

2650 Buford Hwy., Buford, GA 30518