

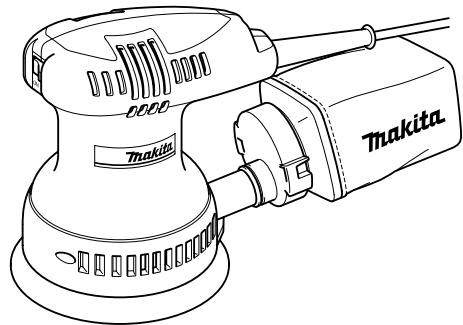

# Random Orbit Sander

MODEL BO5012



## I N S T R U C T I O N   M A N U A L

**⚠ WARNING:**

For your personal safety, READ and UNDERSTAND before using.  
SAVE THESE INSTRUCTIONS FOR FUTURE REFERENCE.

---

# SPECIFICATIONS

Model	BO5012
Pad diameter	123 mm (4-7/8")
Orbit per minute	4,000 - 12,000
Sanding stroke rate	8,000 - 24,000
Dimensions (L x W x H)	150 mm x 123 mm x 146 mm (5-7/8" x 4-7/8" x 5-3/4")
Net weight	1.2kg (2.6 lbs)

- Manufacturer reserves the right to change specifications without notice.
- Specifications may differ from country to country.

---

# GENERAL SAFETY RULES

USA002-2

(For All Tools)

**⚠ WARNING:**  
**Read and understand all instructions.** Failure to follow all instructions listed below, may result in electric shock, fire and/or serious personal injury.

---

# SAVE THESE INSTRUCTIONS

## Work Area

1. **Keep your work area clean and well lit.** Cluttered benches and dark areas invite accidents.
2. **Do not operate power tools in explosive atmospheres, such as in the presence of flammable liquids, gases, or dust.** Power tools create sparks which may ignite the dust or fumes.
3. **Keep bystanders, children, and visitors away while operating a power tool.** Distractions can cause you to lose control.

## Electrical Safety

4. **Double insulated tools are equipped with a polarized plug (one blade is wider than the other.) This plug will fit in a polarized outlet only one way. If the plug does not fit fully in the outlet, reverse the plug. If it still does not fit, contact a qualified electrician to install a polarized outlet. Do not change the plug in any way.** Double insulation  eliminates the need for the three wire grounded power cord and grounded power supply system.

- 
5. **Avoid body contact with grounded surfaces such as pipes, radiators, ranges and refrigerators.** There is an increased risk of electric shock if your body is grounded.
  6. **Do not expose power tools to rain or wet conditions.** Water entering a power tool will increase the risk of electric shock.
  7. **Do not abuse the cord. Never use the cord to carry the tools or pull the plug from an outlet. Keep cord away from heat, oil, sharp edges or moving parts. Replace damaged cords immediately.** Damaged cords increase the risk of electric shock.
  8. **When operating a power tool outside, use an outdoor extension cord marked “W-A” or “W”.** These cords are rated for outdoor use and reduce the risk of electric shock.

### Personal Safety

9. **Stay alert, watch what you are doing and use common sense when operating a power tool. Do not use tool while tired or under the influence of drugs, alcohol, or medication.** A moment of inattention while operating power tools may result in serious personal injury.
10. **Dress properly. Do not wear loose clothing or jewelry. Contain long hair. Keep your hair, clothing, and gloves away from moving parts.** Loose clothes, jewelry, or long hair can be caught in moving parts.
11. **Avoid accidental starting. Be sure switch is off before plugging in.** Carrying tools with your finger on the switch or plugging in tools that have the switch on invites accidents.
12. **Remove adjusting keys or wrenches before turning the tool on.** A wrench or a key that is left attached to a rotating part of the tool may result in personal injury.
13. **Do not overreach. Keep proper footing and balance at all times.** Proper footing and balance enables better control of the tool in unexpected situations.
14. **Use safety equipment. Always wear eye protection.** Dust mask, non-skid safety shoes, hard hat, or hearing protection must be used for appropriate conditions. Ordinary eye or sun glasses are NOT eye protection.

### Tool Use and Care

15. **Use clamps or other practical way to secure and support the workpiece to a stable platform.** Holding the work by hand or against your body is unstable and may lead to loss of control.
16. **Do not force tool. Use the correct tool for your application.** The correct tool will do the job better and safer at the rate for which it is designed.
17. **Do not use tool if switch does not turn it on or off.** Any tool that cannot be controlled with the switch is dangerous and must be repaired.
18. **Disconnect the plug from the power source before making any adjustments, changing accessories, or storing the tool.** Such preventive safety measures reduce the risk of starting the tool accidentally.
19. **Store idle tools out of reach of children and other untrained persons.** Tools are dangerous in the hands of untrained users.
20. **Maintain tools with care. Keep cutting tools sharp and clean.** Properly maintained tools with sharp cutting edges are less likely to bind and are easier to control.
21. **Check for misalignment or binding of moving parts, breakage of parts, and any other condition that may affect the tools operation. If damaged, have the tool serviced before using.** Many accidents are caused by poorly maintained tools.
22. **Use only accessories that are recommended by the manufacturer for your model.** Accessories that may be suitable for one tool, may become hazardous when used on another tool.

## SERVICE

**23. Tool service must be performed only by qualified repair personnel.** Service or maintenance performed by unqualified personnel could result in a risk of injury.

**24. When servicing a tool, use only identical replacement parts. Follow instructions in the Maintenance section of this manual.** Use of unauthorized parts or failure to follow Maintenance instructions may create a risk of electric shock or injury.

**USE PROPER EXTENSION CORD:** Make sure your extension cord is in good condition. When using an extension cord, be sure to use one heavy enough to carry the current your product will draw. An undersized cord will cause a drop in line voltage resulting in loss of power and overheating. Table 1 shows the correct size to use depending on cord length and nameplate ampere rating. If in doubt, use the next heavier gage. The smaller the gage number, the heavier the cord.

**Table 1: Minimum gage for cord**

Ampere Rating		Volts	Total length of cord in feet			
		120 V	25 ft.	50 ft.	100 ft.	150 ft.
More Than	Not More Than	AWG				
0	6		18	16	16	14
6	10		18	16	14	12
10	12		16	16	14	12
12	16		14	12	Not Recommended	

## SPECIFIC SAFETY RULES

USB040-4

**DO NOT let comfort or familiarity with product (gained from repeated use) replace strict adherence to sander safety rules. If you use this tool unsafely or incorrectly, you can suffer serious personal injury.**

1. Hold tool by insulated gripping surfaces when performing an operation where the cutting tool may contact hidden wiring or its own cord. Contact with a “live” wire will make exposed metal parts of the tool “live” and shock the operator.
2. Always use safety glasses or goggles. Ordinary eye or sun glasses are NOT safety glasses.
3. Hold the tool firmly.
4. Do not leave the tool running. Operate the tool only when hand-held.
5. This tool has not been waterproofed, so do not use water on the workpiece surface.
6. Ventilate your work area adequately when you perform sanding operations.
7. Use of this tool to sand some products, paints and wood could expose user to dust containing hazardous substances. Use appropriate respiratory protection.

---

# SAVE THESE INSTRUCTIONS

**⚠ WARNING:**  
**MISUSE or failure to follow the safety rules stated in this instruction manual may cause serious personal injury.**

---

## SYMBOLS

USD205-1

The followings show the symbols used for tool.

**V** ..... volts

**A** ..... amperes

**Hz** ..... hertz

 .....alternating current

$n_0$  .....no load speed

 .....Class II Construction

**.../min**..... orbits per minute

# FUNCTIONAL DESCRIPTION

**⚠ CAUTION:**

- Always be sure that the tool is switched off and unplugged before adjusting or checking function on the tool.

## Switch action

**⚠ CAUTION:**

- Before plugging in the tool, always be sure that the tool is switched off.

To start the tool, press the “I ( ON )” side of the switch. To stop, press the “O ( OFF )” side of the switch.

002528

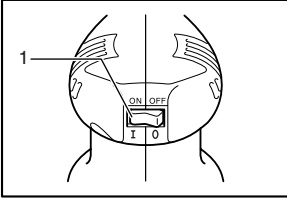

1. Switch

002529

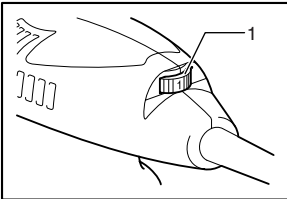

1. Speed adjusting dial

## Speed adjusting dial

The tool speed can be infinitely adjusted between 4,000 opm and 12,000 opm by turning the speed adjusting dial, which is marked 1 to 5. Higher speed is obtained when the dial is turned in the direction of number 5; lower speed is obtained when it is turned in the direction of number 1. Refer to the figure below for the relationship between the number setting on the adjusting dial and the kind of work.

002530

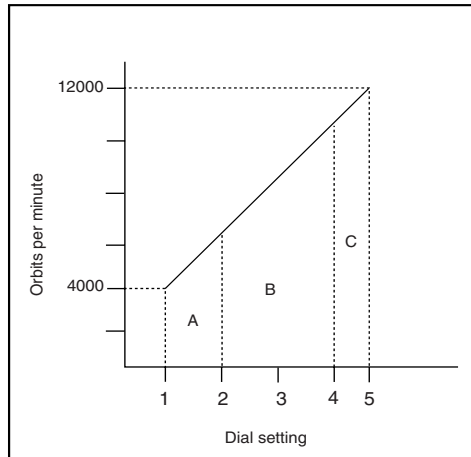

- A range: For polishing
- B range: For finish sanding
- C range: For regular sanding

**NOTE:**

- The above figure shows standard applications. They may differ under certain conditions.

002531

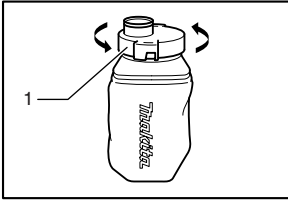

1. Dust nozzle

**Emptying dust bag**

When the dust bag is about half full, switch off and unplug the tool. Remove the dust bag from the tool. Then remove the dust nozzle from the dust bag after unlocking the dust nozzle by turning it slightly counterclockwise. Empty the dust bag by tapping it lightly.

002532

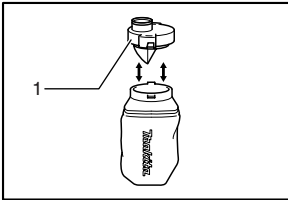

1. Dust nozzle

After emptying the dust bag, install the dust nozzle on the dust bag. Turn the dust nozzle slightly clockwise to lock it in place. Then install the dust bag on the tool as described in "Installing dust bag".

**ASSEMBLY**

**⚠ CAUTION:**

- Always be sure that the tool is switched off and unplugged before carrying out any work on the tool.

002533

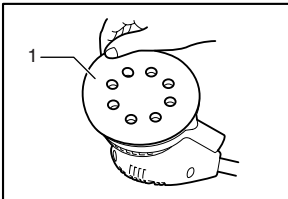

1. Abrasive disc

**Installing or removing abrasive disc**

To install the abrasive disc, first remove all dirt or foreign matter from the pad. Then attach the abrasive disc to the pad, using the hook-and-loop system of the abrasive disc and the pad. Be careful to align the holes in the abrasive disc with those in the pad.

**⚠ CAUTION:**

- Always use hook-and-loop system abrasive discs. Never use pressure-sensitive abrasive discs.

002534

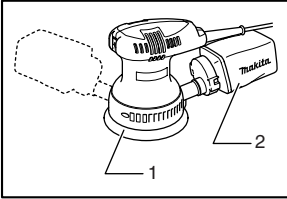

1. Skirt
2. Dust bag

## Installing dust bag

Install the dust bag on the tool so that the Makita logo on the dust bag will be upright (not upside down). The dust bag can be swiveled 360°. Position the skirt so that the dust bag will not interfere with your work.

## OPERATION

002535

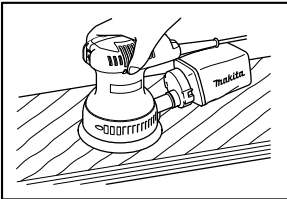

## Sanding operation

Turn the tool on and wait until it attains full speed. Then gently place the tool on the workpiece surface. Keep the pad flush with the workpiece and apply slight pressure on the tool.

### ⚠ CAUTION:

- Never run the tool without the abrasive disc. You may seriously damage the pad.
- Never force the tool. Excessive pressure may decrease the sanding efficiency, damage the abrasive disc or shorten tool life.

## Polishing operation

### ⚠ CAUTION:

- Use only a Makita genuine sponge pad, felt pad or wool pad (optional accessories).
- Always operate the tool at low speed to prevent work surfaces from heating abnormally.
- Never force the tool. Excessive pressure may decrease the polishing efficiency and cause motor overload, resulting in tool malfunction.

002536

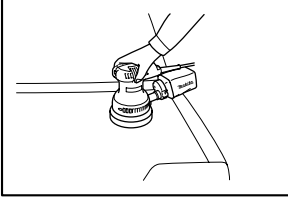

### 1. Applying wax

Use an optional sponge pad. Apply wax to the sponge pad or work surface. Run the tool at low speed to smooth out wax.

#### NOTE:

- First, wax a not conspicuous portion of the work surface to make sure that the tool will not scratch the surface or result in uneven waxing.
- Always run the tool at low speed. Running it at high speed may cause the wax to spatter.

002537

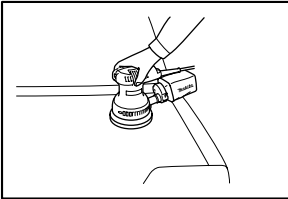

### 2. Removing wax

Use an optional felt pad. Run the tool at low speed to remove wax.

002538

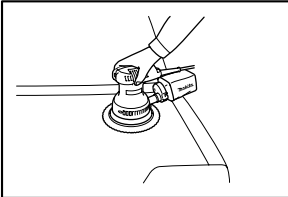

### 3. Polishing

Use an optional wool pad. Run the tool at low speed and apply the wool pad gently to the work surface.

## MAINTENANCE

#### ⚠ CAUTION:

- Always be sure that the tool is switched off and unplugged before attempting to perform inspection or maintenance.

To maintain product SAFETY and RELIABILITY, repairs, carbon brush inspection and replacement, any other maintenance or adjustment should be performed by Makita Authorized or Factory Service Centers, always using Makita replacement parts.

---

## ACCESSORIES

**⚠ CAUTION:**

- These accessories or attachments are recommended for use with your Makita tool specified in this manual. The use of any other accessories or attachments might present a risk of injury to persons. Only use accessory or attachment for its stated purpose.

If you need any assistance for more details regarding these accessories, ask your local Makita service center.

- Hook-and-loop system abrasive disc (with pre-punched holes)
- Hook-and-loop system sponge pad
- Hook-and-loop system felt pad
- Hook-and-loop system wool pad





Cut



First-Class  
Postage  
Required

Post Office will  
not deliver  
without proper  
postage.

**Makita U.S.A., Inc.**  
14930 Northam Street  
La Mirada, CA 90638-5753



Fold

# MAIL THIS PORTION

Your answers to the following questions are appreciated.

**1. This product was purchased from:**

- Home Center       Other (                    )  
 Hardware/Lumber Store  
 Tool Distributor  
 Industrial Supply  
 Construction Supply

**3. How did you learn about this product:**

- Magazine       Radio  
 From Dealer       Exhibition  
 Newspaper       From Friend  
 Store Display       Previous Usage  
 Catalog       Other (                    )

**2. Use of the product is intended for:**

- Construction Trade  
 Industrial Maintenance  
 Home Maintenance  
 Hobby  
 Other (                    )

**4. Most favored points are:**

- Design       Repair Service  
 Features       Durability  
 Size       Power  
 Price       Other (                    )  
 Makita Brand

**5. Any comments:**

---



---



---



---

DATE PURCHASED			MODEL NO.																			
MONTH		DAY		YEAR		SERIAL NO.																
						INTL.						LAST NAME / COMPANY NAME						STATUS		SEX		
																			Married	Single	M	F
STREET ADDRESS																						
CITY																						
STATE		ZIP CODE				PHONE				AREA CODE												
AGE:		<input type="checkbox"/> Under 19		<input type="checkbox"/> 20-29		<input type="checkbox"/> 30-39		<input type="checkbox"/> 40-49		<input type="checkbox"/> 50-60		<input type="checkbox"/> Over 60										

BE SURE TO COMPLETE THE CUSTOMER'S PORTION OF THIS FORM AND RETAIN FOR YOUR RECORDS.

Please return this portion by facsimile or mail.

Facsimile No: (714) 522-8133

# FACTORY SERVICE CENTERS

1-800-4-MAKITA

RETAIN THIS PORTION FOR YOUR RECORDS

## ALABAMA

2365 Pelham Parkway  
Pelham, AL 35124  
(205) 620-1791

## ARIZONA

3707 E. Broadway Rd., Ste. 6  
Phoenix, AZ 85040  
(602) 437-2850

## ARKANSAS

Shackelford Shopping Center  
240 South Shackelford Rd.,  
Ste. C  
Little Rock, AR 72211  
(501) 224-5733

## CALIFORNIA

41850 Christy St.  
Fremont, CA 94538-5107  
(510) 657-9881

1421 N. Clovis Ave., Ste. 112  
Fresno, CA 93727  
(559) 252-5166

14930 Northam St.  
La Mirada, CA 90638-5753  
(714) 522-9089

1970 Fulton Avenue  
Sacramento, CA 95825  
(916) 482-5197

1440 South "E" Street  
San Bernardino, CA 92408  
(909) 885-1289

7674 Clairemont Mesa Blvd.  
San Diego, CA 92111  
(858) 278-4471

1565 Winchester B.  
Campbell, CA 95008-0501  
(408) 379-0377

16735 Saticoy St., Ste. 105  
Van Nuys, CA 91406  
(818) 782-2440

## COLORADO

11839 E. 51st Ave.  
Denver, CO 80239-2709  
(303) 371-2850

## FLORIDA

620 Douglas Ave. Suite 1302  
Altamonte Springs, FL 32714  
(407) 774-6000

750 East Sample Road  
Pompano Beach, FL 33064  
(954) 781-6333

Thompson Center Waters  
5501 W. Waters Ave., Ste. 406  
Tampa, FL 33634  
(813) 886-8292

## GEORGIA

4680 River Green Parkway  
Duluth, GA 30096-2566  
(770) 476-8911

## ILLINOIS

1450 Feehanville Dr.  
Mt. Prospect, IL 60056-6011  
(847) 297-3100

## INDIANA

8403 Michigan Road, Unit 1  
Indianapolis, IN 46268  
(317) 334-9980

## KANSAS

8819 W. 95th St.  
Overland Park, KS 66212  
(913) 642-1111

## KENTUCKY

1215 S. Hurstbourne Parkway  
Louisville, KY 40222  
(502) 326-3740

## LOUISIANA

5626 Jefferson Hwy.  
Harahan, LA 70123  
(504) 733-4138

## MARYLAND

7541 - 45 Ritchie Highway  
Glen Burnie, MD 21061  
(410) 590-0160

## MASSACHUSETTS

232 Providence Hwy.  
Westwood, MA 02090  
(617) 461-9754

## MINNESOTA

6427 Penn Ave. South  
Richfield, MN 55423  
(612) 869-5199

## MISSOURI

9876 Watson Road  
St. Louis, MO 63126-2221  
(314) 909-9889

## NEBRASKA

4129 S. 84th St.  
Omaha, NE 68127  
(402) 597-2925

## NEVADA

3375 S. Decatur Blvd.  
Suites 22 - 24  
Las Vegas, NV 89102  
(702) 368-4277

## NEW JERSEY

251 Herrod Blvd.  
Dayton, NJ 08810-1539  
(609) 655-1212

## NEW YORK

4917 Genessee Street  
Cheektowaga, NY 14225  
(716) 685-9503

131-35 31st Ave.  
Flushing, NY 11354  
(718) 886-0971

## NORTH CAROLINA

3501-G S. Tryon St.  
Charlotte, NC 28217  
(704) 527-0611

## OHIO

6253 E. Main St.  
Columbus, OH 43213  
(614) 860-0222

6379 Pearl Road  
Parma Heights, OH 44130  
(440) 843-7555

1617 E. Kemper Rd.  
Sharonville, OH 45246  
(513) 771-0788

## OKLAHOMA

552 E. Memorial Road  
Oklahoma City, OK 73114  
(405) 752-2655

## OREGON

828 19th Avenue., N.W.  
Portland, OR 97209  
(503) 222-1823

## PENNSYLVANIA

Springwater Plaza  
364 Wilmington W. Chester  
Pike  
Glen Mills, PA 19342  
(610) 459-4122

6200 Babcock Blvd  
Pittsburgh, PA 15237  
(412) 366-6363

## PUERTO RICO

200 Guayama St.  
Hato Rey, PR 00917  
(787) 250-8776

## TENNESSEE

4655 Nolensville Rd.  
Nashville, TN 37211  
(615) 331-9922

## TEXAS

12801 Stemmons Fwy Ste. 809  
Farmers Branch, TX 75234  
(972) 243-1150

12701 Directors Dr.  
Stafford, TX 77477-3701  
(281) 955-8665

3453 IH-35 North, Ste. 101  
San Antonio, TX 78219  
(210) 228-0676

## UTAH

145 E. 1300 S., Ste. 101  
Salt Lake City, UT 84115  
(801) 359-3410

## WASHINGTON

22220 84th Ave. So., Bldg. A  
Kent, WA 98032  
(253) 395-8055

## WISCONSIN

Lincoln Plaza Shopping Ctr.  
2245 S. 108th St. West Allis, WI  
53227  
(414) 541-4776

## CUSTOMER'S RECORD

<p><b>When you need service:</b> Send complete tool (prepaid) to one of the Makita Factory Service Centers listed, or to an Authorized Makita Service Center. Be sure to attach a letter to the outside of the carton detailing the problem with your tool.</p>	Date Purchased
	Dealer's Name & Address
	Model No.
	Serial No.

# WARNING

Some dust created by power sanding, sawing, grinding, drilling, and other construction activities contains chemicals known to the State of California to cause cancer, birth defects or other reproductive harm. Some examples of these chemicals are:

- lead from lead-based paints,
- crystalline silica from bricks and cement and other masonry products, and
- arsenic and chromium from chemically-treated lumber.

Your risk from these exposures varies, depending on how often you do this type of work. To reduce your exposure to these chemicals: work in a well ventilated area, and work with approved safety equipment, such as those dust masks that are specially designed to filter out microscopic particles.

## MAKITA LIMITED ONE YEAR WARRANTY

### Warranty Policy

Every Makita tool is thoroughly inspected and tested before leaving the factory. It is warranted to be free of defects from workmanship and materials for the period of ONE YEAR from the date of original purchase. Should any trouble develop during this one year period, return the COMPLETE tool, freight prepaid, to one of Makita's Factory or Authorized Service Centers. If inspection shows the trouble is caused by defective workmanship or material, Makita will repair (or at our option, replace) without charge.

This Warranty does not apply where:

- repairs have been made or attempted by others:
- repairs are required because of normal wear and tear:
- the tool has been abused, misused or improperly maintained:
- alterations have been made to the tool.

IN NO EVENT SHALL MAKITA BE LIABLE FOR ANY INDIRECT, INCIDENTAL OR CONSEQUENTIAL DAMAGES FROM THE SALE OR USE OF THE PRODUCT. THIS DISCLAIMER APPLIES BOTH DURING AND AFTER THE TERM OF THIS WARRANTY.

MAKITA DISCLAIMS LIABILITY FOR ANY IMPLIED WARRANTIES, INCLUDING IMPLIED WARRANTIES OF "MERCHANTABILITY" AND "FITNESS FOR A SPECIFIC PURPOSE," AFTER THE ONE YEAR TERM OF THIS WARRANTY.

This Warranty gives you specific legal rights, and you may also have other rights which vary from state to state. Some states do not allow the exclusion or limitation of incidental or consequential damages, so the above limitation or exclusion may not apply to you. Some states do not allow limitation on how long an implied warranty lasts, so the above limitation may not apply to you.

**Makita Corporation of America**

2650 Buford Hwy., Buford, GA 30518